

580N
580SN WT
580SN
590SN
Tier 4B (final)
Tractor Loader Backhoe

*580N PIN NHC740665 and above; 580SN WT PIN NHC745126 and above;
580SN PIN NHC743044 and above; 590SN PIN NHC746245 and above*

SERVICE MANUAL

Part number 48194558

1st edition English

October 2017

CASE
CONSTRUCTION



SERVICE MANUAL

580N Four-Wheel Drive (4WD) Tier 4B (final) [NHC740665 -], 580N Two-Wheel Drive (2WD) Tier 4B (final) [NHC740665 -], 580SN Four-Wheel Drive (4WD) Tier 4B (final) [NHC743044 -], 580SN Two-Wheel Drive (2WD) Tier 4B (final) [NHC743044 -], 580SN WT Four-Wheel Drive (4WD) Tier 4B (final), Wide Track [NHC745126 -], 590SN Four-Wheel Drive (4WD) Tier 4B (final) [NHC746245 -], 590SN Two-Wheel Drive (2WD) Tier 4B (final) [NHC746245 -]

Link Product / Engine

Product	Market Product	Engine
580N Two-Wheel Drive (2WD) Tier 4B (final) [NHC740665 -]	North America	F5BFL413A*B007
580N Four-Wheel Drive (4WD) Tier 4B (final) [NHC740665 -]	North America	F5BFL413A*B007
580SN Two-Wheel Drive (2WD) Tier 4B (final) [NHC743044 -]	North America	F5BFL413A*B007
580SN Four-Wheel Drive (4WD) Tier 4B (final) [NHC743044 -]	North America	F5BFL413A*B007
580SN WT Four-Wheel Drive (4WD) Tier 4B (final), Wide Track [NHC745126 -]	North America	F5BFL413A*B007
590SN Two-Wheel Drive (2WD) Tier 4B (final) [NHC746245 -]	North America	F5BFL413A*B007
590SN Four-Wheel Drive (4WD) Tier 4B (final) [NHC746245 -]	North America	F5BFL413A*B007

Contents

INTRODUCTION

Engine	10
[10.001] Engine and crankcase	10.1
[10.103] Crankshaft and flywheel.....	10.2
[10.206] Fuel filters	10.3
[10.216] Fuel tanks	10.4
[10.218] Fuel injection system.....	10.5
[10.304] Engine lubrication system.....	10.6
[10.400] Engine cooling system	10.7
[10.414] Fan and drive	10.8
[10.500] Selective Catalytic Reduction (SCR) exhaust treatment.....	10.9
Transmission	21
[21.112] Power shuttle transmission.....	21.1
[21.113] Powershift transmission	21.2
[21.134] Power shuttle transmission external controls	21.3
[21.135] Powershift transmission external controls.....	21.4
[21.154] Power shuttle transmission internal components	21.5
[21.155] Powershift transmission internal components.....	21.6
Front axle system	25
[25.100] Powered front axle	25.1
[25.102] Front bevel gear set and differential	25.2
[25.108] Final drive hub, steering knuckles, and shafts	25.3
[25.400] Non-powered front axle	25.4
Rear axle system	27
[27.100] Powered rear axle.....	27.1
[27.106] Rear bevel gear set and differential	27.2

[27.120] Planetary and final drives	27.3
Brakes and controls	33
[33.110] Parking brake or parking lock	33.1
[33.202] Hydraulic service brakes	33.2
Hydraulic systems.....	35
[35.000] Hydraulic systems.....	35.1
[35.102] Pump control valves.....	35.2
[35.104] Fixed displacement pump	35.3
[35.106] Variable displacement pump	35.4
[35.204] Remote control valves	35.5
[35.300] Reservoir, cooler, and filters.....	35.6
[35.350] Safety and main relief valves	35.7
[35.357] Pilot system	35.8
[35.359] Main control valve	35.9
[35.525] Auxiliary hydraulic valves and lines	35.10
[35.701] Front loader arm hydraulic system	35.11
[35.703] Stabilizer hydraulic system	35.12
[35.723] Front loader bucket hydraulic system	35.13
[35.726] Excavator and backhoe hydraulic controls.....	35.14
[35.736] Boom hydraulic system	35.15
[35.737] Dipper hydraulic system.....	35.16
[35.738] Excavator and backhoe bucket hydraulic system.....	35.17
[35.739] Swing arm hydraulic system	35.18
[35.740] Telescopic arm hydraulic system.....	35.19
Frames and ballasting	39
[39.100] Frame	39.1
[39.129] Stabilizers	39.2
Steering.....	41

[41.101] Steering control	41.1
[41.200] Hydraulic control components.....	41.2
[41.216] Cylinders	41.3
Wheels	44
[44.511] Front wheels.....	44.1
[44.520] Rear wheels	44.2
Cab climate control	50
[50.100] Heating	50.1
[50.200] Air conditioning.....	50.2
Electrical systems	55
[55.024] Transmission control system	55.1
[55.100] Harnesses and connectors.....	55.2
[55.201] Engine starting system	55.3
[55.301] Alternator.....	55.4
[55.302] Battery.....	55.5
[55.404] External lighting	55.6
[55.408] Warning indicators, alarms, and instruments	55.7
[55.510] Cab or platform harnesses and connectors.....	55.8
[55.640] Electronic modules	55.9
[55.988] Selective Catalytic Reduction (SCR) electrical system	55.10
[55.991] Telematics	55.11
[55.DTC] FAULT CODES.....	55.12
Front loader and bucket.....	82
[82.100] Arm.....	82.1
[82.300] Bucket.....	82.2
Booms, dippers, and buckets	84
[84.100] Bucket.....	84.1
[84.114] Boom pivoting support	84.2

[84.910] Boom	84.3
[84.912] Dipper arm	84.4
Platform, cab, bodywork, and decals	90
[90.100] Engine hood and panels	90.1
[90.114] Operator protections	90.2
[90.124] Pneumatically-adjusted operator seat.....	90.3
[90.150] Cab.....	90.4
[90.151] Cab interior.....	90.5
[90.154] Cab doors and hatches	90.6
[90.156] Cab windshield and windows	90.7



INTRODUCTION

Contents

INTRODUCTION

Foreword - Important notice regarding equipment servicing	4
Safety rules	5
Safety rules - Personal safety	6
Safety rules - Ductile iron	7
Safety rules - Ecology and the environment	8
Basic instructions - Shop and assembly	9
Basic instructions - Fuse and relay locations	11
Basic instructions - Fuse, relay, and diode icon definitions	16
Basic instructions - Releasing hydraulic pressure on machines with pilot backhoe controls .	25
Basic instructions - Releasing hydraulic pressure on machines with mechanical backhoe controls	27
Basic instructions - Diagnostic service tool port	28
Basic instructions - Hydraulic diagnostic test ports	29
Basic instructions - Welding on the machine	31
Basic instructions - Heater coolant shutoff valve	35
Engine cooling system - Basic instructions	36
Basic instructions - Support strut for loader lift arm	38
Basic instructions - Hood	41
Torque - Minimum tightening torques for normal assembly	42
Torque - Standard torque data for hydraulics	47
Basic instructions - Snap-to-Connect (STC®) hydraulic connectors	63
Abbreviation Measurements	68
Capacities and fluids - 580N (factory fill) (*)	70
Capacities and fluids - 580SN (factory fill) (*)	72
Capacities and fluids - 580SN WT (factory fill) (*)	74
Capacities and fluids - 590SN (factory fill) (*)	76
Consumables	78
General specification	80
General specification - Severe Cold Weather Package (SCWP)	81
Hydraulic contamination	82
General specification - Engine (*)	83
General specification - Engine (*)	84
General specification - Engine (*)	85
General specification - Electrical	86

(*) See content for specific models

General specification - Powertrain	87
General specification - Hydraulics	89
General specification - Travel speeds	90
General specification - Machine overall dimensions	93
General specification - Loader lift capacities	97
General specification - Backhoe/Extendahoe specifications and lifting capacities	98
General specification - Noise levels	132
Product identification - Machine orientation	133
Part identification	134
Product identification - Product Identification Number (PIN)	136

Foreword - Important notice regarding equipment servicing

All repair and maintenance work listed in this manual must be carried out only by qualified dealership personnel, strictly complying with the instructions given, and using, whenever possible, the special tools.

Anyone who performs repair and maintenance operations without complying with the procedures provided herein shall be responsible for any subsequent damages.

The manufacturer and all the organizations of its distribution chain, including - without limitation - national, regional, or local dealers, reject any responsibility for damages caused by parts and/or components not approved by the manufacturer, including those used for the servicing or repair of the product manufactured or marketed by the manufacturer. In any case, no warranty is given or attributed on the product manufactured or marketed by the manufacturer in case of damages caused by parts and/or components not approved by the manufacturer.

The manufacturer reserves the right to make improvements in design and changes in specifications at any time without notice and without incurring any obligation to install them on units previously sold. Specifications, descriptions, and illustrative material herein are as accurate as known at time of publication but are subject to change without notice.

In case of questions, refer to your CASE CONSTRUCTION Sales and Service Networks.

Safety rules

Personal safety





This is the safety alert symbol. It is used to alert you to potential personal injury hazards. Obey all safety messages that follow this symbol to avoid possible death or injury.

Throughout this manual you will find the signal words DANGER, WARNING, and CAUTION followed by special instructions. These precautions are intended for the personal safety of you and those working with you.

Read and understand all the safety messages in this manual before you operate or service the machine.

 DANGER indicates a hazardous situation that, if not avoided, will result in death or serious injury.

 WARNING indicates a hazardous situation that, if not avoided, could result in death or serious injury.

 CAUTION indicates a hazardous situation that, if not avoided, could result in minor or moderate injury.

FAILURE TO FOLLOW DANGER, WARNING, AND CAUTION MESSAGES COULD RESULT IN DEATH OR SERIOUS INJURY.

Machine safety

NOTICE: Notice indicates a situation that, if not avoided, could result in machine or property damage.

Throughout this manual you will find the signal word Notice followed by special instructions to prevent machine or property damage. The word Notice is used to address practices not related to personal safety.

Information

NOTE: Note indicates additional information that clarifies steps, procedures, or other information in this manual.

Throughout this manual you will find the word Note followed by additional information about a step, procedure, or other information in the manual. The word Note is not intended to address personal safety or property damage.

Safety rules - Personal safety

Unless otherwise instructed, always perform these steps before you service the machine:

1. Park the machine on a flat, level surface.
2. Place the backhoe in the transport position with the swing lock pin installed for transport.
3. Place the loader bucket on the ground, with the bottom of the loader bucket parallel to the surface.
4. Place the direction control lever and the transmission in neutral.
5. If you need to open the hood to perform service, raise the loader arms and install the support strut.
6. Shut down the engine.
7. Place a 'Do Not Operate' tag on the key switch so that it is visible to other workers or remove the key.

Safety rules - Ductile iron



▲ DANGER

Altering cast ductile iron can cause it to weaken or break.

Before you weld, cut, or drill holes on any part of this machine, make sure that the part is not cast ductile iron.

Failure to comply will result in death or serious injury.

D0148A

Altering cast ductile iron can cause it to weaken or break. Unauthorized modifications to cast ductile iron parts can cause death or serious injury. Do not weld, cut, drill, repair, or attach items to cast ductile iron parts on this machine.

Before you weld, cut, or drill holes on any part of this machine, make sure the part is not cast ductile iron. See your dealer if you do not know if a part is cast ductile iron.

The following items are examples of cast ductile iron parts. There may also be other parts made of cast ductile iron that are not on the list below.

- two-wheel drive steering link
- dump links
- front axle
- stabilizers
- extend-a-hoe
- swing tower
- bucket linkage
- Air-Conditioning (A/C) compressor mounting bracket

Do not make any unauthorized modifications. Consult an authorized dealer before making any changes, additions, or modifications to this machine.

Safety rules - Ecology and the environment

Soil, air, and water quality is important for all industries and life in general. When legislation does not yet rule the treatment of some of the substances that advanced technology requires, sound judgment should govern the use and disposal of products of a chemical and petrochemical nature.

Familiarize yourself with the relative legislation applicable to your country, and make sure that you understand this legislation. Where no legislation exists, obtain information from suppliers of oils, filters, batteries, fuels, anti-freeze, cleaning agents, etc., with regard to the effect of these substances on man and nature and how to safely store, use, and dispose of these substances.

Helpful hints

- Avoid the use of cans or other inappropriate pressurized fuel delivery systems to fill tanks. Such delivery systems may cause considerable spillage.
- In general, avoid skin contact with all fuels, oils, acids, solvents, etc. Most of these products contain substances that may be harmful to your health.
- Modern oils contain additives. Do not burn contaminated fuels and or waste oils in ordinary heating systems.
- Avoid spillage when you drain fluids such as used engine coolant mixtures, engine oil, hydraulic fluid, brake fluid, etc. Do not mix drained brake fluids or fuels with lubricants. Store all drained fluids safely until you can dispose of the fluids in a proper way that complies with all local legislation and available resources.
- Do not allow coolant mixtures to get into the soil. Collect and dispose of coolant mixtures properly.
- The air-conditioning system contains gases that should not be released into the atmosphere. Consult an air-conditioning specialist or use a special extractor to recharge the system properly.
- Repair any leaks or defects in the engine cooling system or hydraulic system immediately.
- Do not increase the pressure in a pressurized circuit as this may lead to a component failure.
- Protect hoses during welding. Penetrating weld splatter may burn a hole or weaken hoses, allowing the loss of oils, coolant, etc.

Battery recycling

Batteries and electric accumulators contain several substances that can have a harmful effect on the environment if the batteries are not properly recycled after use. Improper disposal of batteries can contaminate the soil, groundwater, and waterways. CASE CONSTRUCTION strongly recommends that you return all used batteries to a CASE CONSTRUCTION dealer, who will dispose of the used batteries or recycle the used batteries properly. In some countries, this is a legal requirement.



Mandatory battery recycling

NOTE: The following requirements are mandatory in Brazil.

Batteries are made of lead plates and a sulfuric acid solution. Because batteries contain heavy metals such as lead, CONAMA Resolution 401/2008 requires you to return all used batteries to the battery dealer when you replace any batteries. Do not dispose of batteries in your household garbage.

Points of sale are obliged to:

- Accept the return of your used batteries
- Store the returned batteries in a suitable location
- Send the returned batteries to the battery manufacturer for recycling

Basic instructions - Shop and assembly

Shimming

For each adjustment operation, select adjusting shims and measure the adjusting shims individually using a micrometer, then add up the recorded values. Do not rely on measuring the entire shimming set, which may be incorrect, or the rated value shown on each shim.

Rotating shaft seals

For correct rotating shaft seal installation, proceed as follows:

1. Before assembly, allow the seal to soak in the oil it will be sealing for at least thirty minutes.
2. Thoroughly clean the shaft and check that the working surface on the shaft is not damaged.
3. Position the sealing lip facing the fluid.

NOTE: *With hydrodynamic lips, take into consideration the shaft rotation direction and position the grooves so that they will move the fluid towards the inner side of the seal.*

4. Coat the sealing lip with a thin layer of lubricant (use oil rather than grease). Fill the gap between the sealing lip and the dust lip on double lip seals with grease.
5. Insert the seal in its seat and press down using a flat punch or seal installation tool. Do not tap the seal with a hammer or mallet.
6. While you insert the seal, check that the seal is perpendicular to the seat. When the seal settles, make sure that the seal makes contact with the thrust element, if required.
7. To prevent damage to the seal lip on the shaft, position a protective guard during installation operations.

O-ring seals

Lubricate the O-ring seals before you insert them in the seats. This will prevent the O-ring seals from overturning and twisting, which would jeopardize sealing efficiency.

Sealing compounds

Apply a sealing compound on the mating surfaces when specified by the procedure. Before you apply the sealing compound, prepare the surfaces as directed by the product container.

Spare parts

Only use CNH Original Parts or CASE CONSTRUCTION Original Parts.

Only genuine spare parts guarantee the same quality, duration, and safety as original parts, as they are the same parts that are assembled during standard production. Only CNH Original Parts or CASE CONSTRUCTION Original Parts can offer this guarantee.

When ordering spare parts, always provide the following information:

- Machine model (commercial name) and Product Identification Number (PIN)
- Part number of the ordered part, which can be found in the parts catalog

Protecting the electronic and/or electrical systems during charging and welding

To avoid damage to the electronic and/or electrical systems, always observe the following practices:

1. Never make or break any of the charging circuit connections when the engine is running, including the battery connections.
2. Never short any of the charging components to ground.
3. Always disconnect the ground cable from the battery before arc welding on the machine or on any machine attachment.
 - Position the welder ground clamp as close to the welding area as possible.
 - If you weld in close proximity to a computer module, then you should remove the module from the machine.
 - Never allow welding cables to lie on, near, or across any electrical wiring or electronic component while you weld.
4. Always disconnect the negative cable from the battery when charging the battery in the machine with a battery charger.

NOTICE: *If you must weld on the unit, you must disconnect the battery ground cable from the machine battery. The electronic monitoring system and charging system will be damaged if this is not done.*

5. Remove the battery ground cable. Reconnect the cable when you complete welding.

WARNING

Battery acid causes burns. Batteries contain sulfuric acid.

Avoid contact with skin, eyes or clothing. Antidote (external): Flush with water. Antidote (eyes): flush with water for 15 minutes and seek medical attention immediately. Antidote (internal): Drink large quantities of water or milk. Do not induce vomiting. Seek medical attention immediately. Failure to comply could result in death or serious injury.

W0111A

Special tools

The special tools that CASE CONSTRUCTION suggests and illustrate in this manual have been specifically researched and designed for use with CASE CONSTRUCTION machines. The special tools are essential for reliable repair operations. The special tools are accurately built and rigorously tested to offer efficient and long-lasting operation.

By using these tools, repair personnel will benefit from:

- Operating in optimal technical conditions
- Obtaining the best results
- Saving time and effort
- Working in safe conditions

Basic instructions - Fuse and relay locations

The machine is equipped with easily accessible fuse and relay locations.

Front console box

1. Turn the thumb screw (1) to loosen the panel cover (2) for the fuse box. Remove the panel cover.

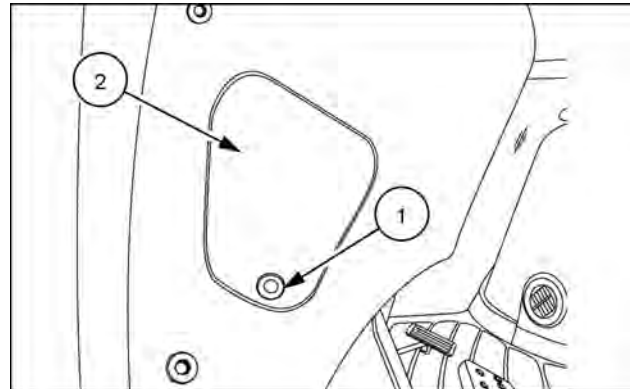

RCPH10TLB320AAF 1

2. Remove the fuse box cover.

NOTE: The fuse and relay decal is on the underside of the cover.

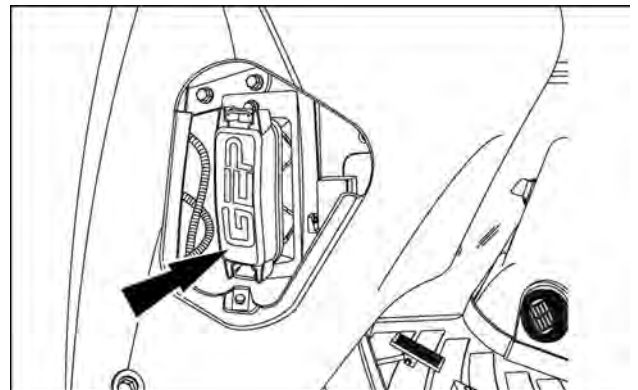

RCPH10TLB307AAF 2

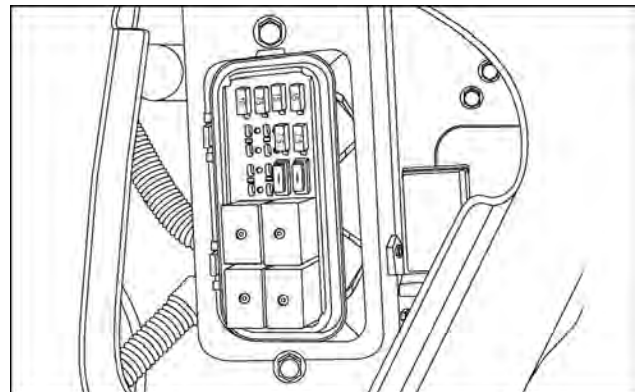

RCPH10TLB303AAF 3

Front console ECU fuse and relay

1. Remove the cover from the steering column shroud.

NOTE: The fuse and relay decal is on the underside of the steering column shroud cover.

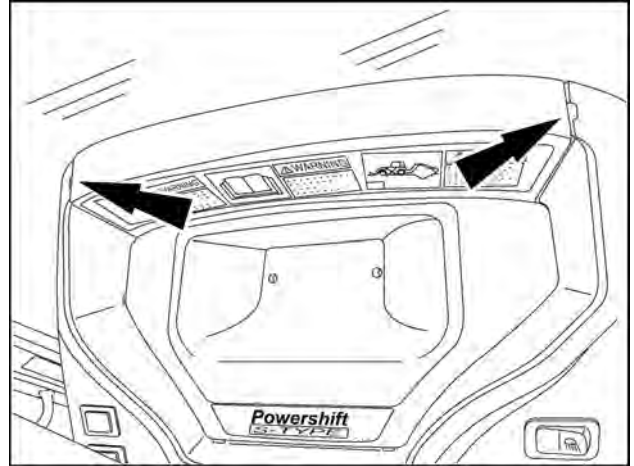

RCPH11TLB012BAD 4

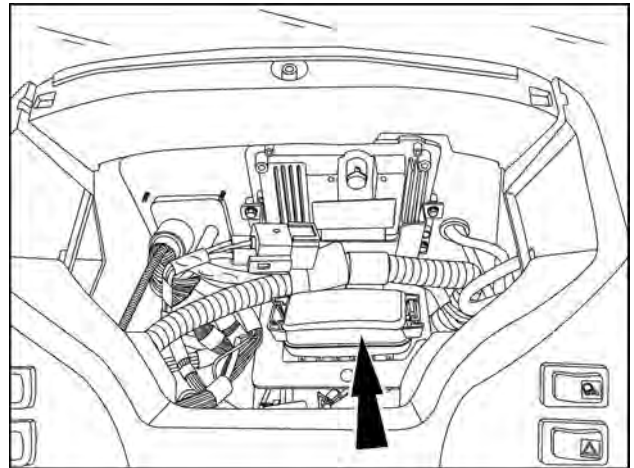

RAIL14TLB01061BA 5

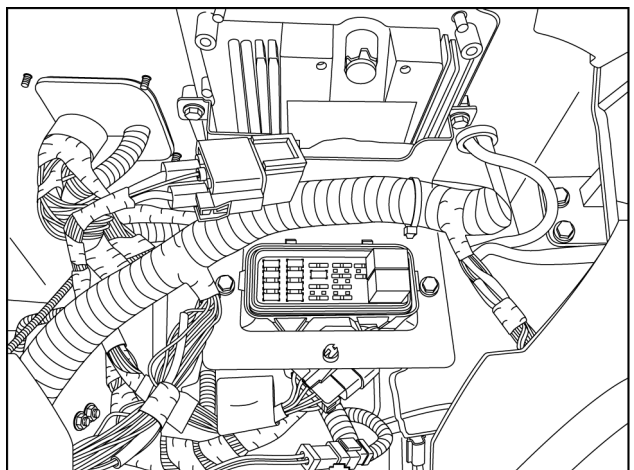

RAIL15TLB0001BA 6

Side console box

1. Turn the thumb screws **(1)** to loosen the panel cover **(2)** for the fuse box. Remove the panel cover.

NOTE: The fuse and relay decal is on the underside of the cover.

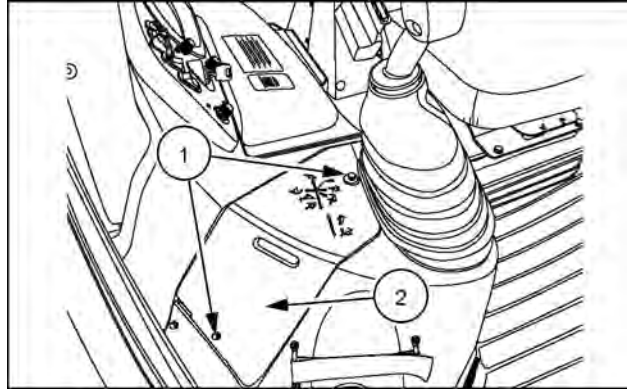

RCPH10TLB437AAF 7

2. Remove the fuse box covers as needed.

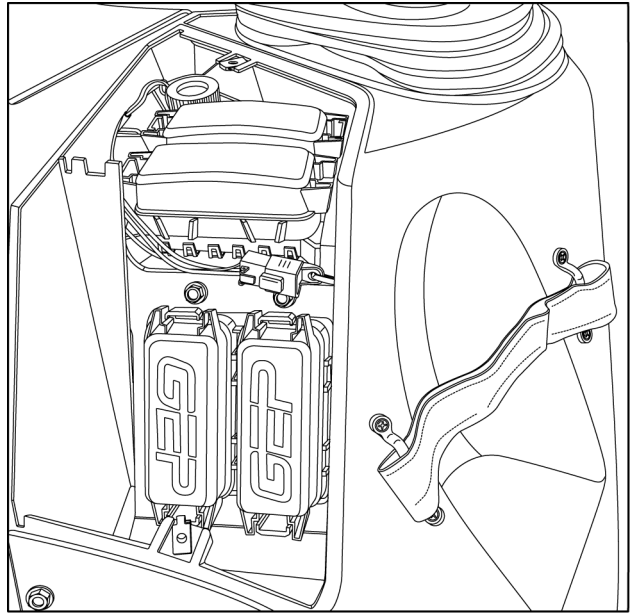

RAIL14TLB1053BA 8

1. Remove the instrument cluster.

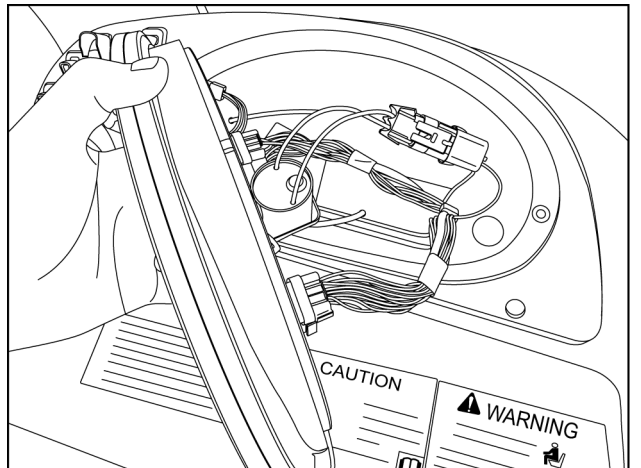

RAIL15TLB0007BA 9

INTRODUCTION

2. Locate the fuse and relay box. Refer to the decal for fuse, relay, and/or diode functions.

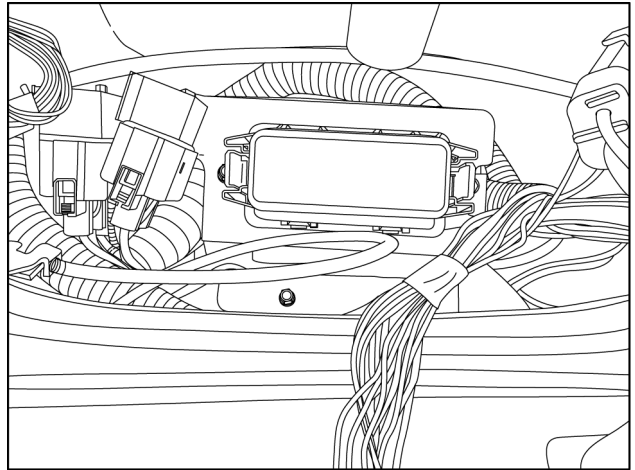

RAIL15TLB0008BA 10

Glow-plug Control Unit (GCU) fuse and dosing heater fuse

1. Raise the loader arm and engage the safety support.
2. Lift the engine hood.
3. Locate the GCU fuse (1) and the dosing heater fuse (2) on the right-hand side of the engine attached to the cab frame.

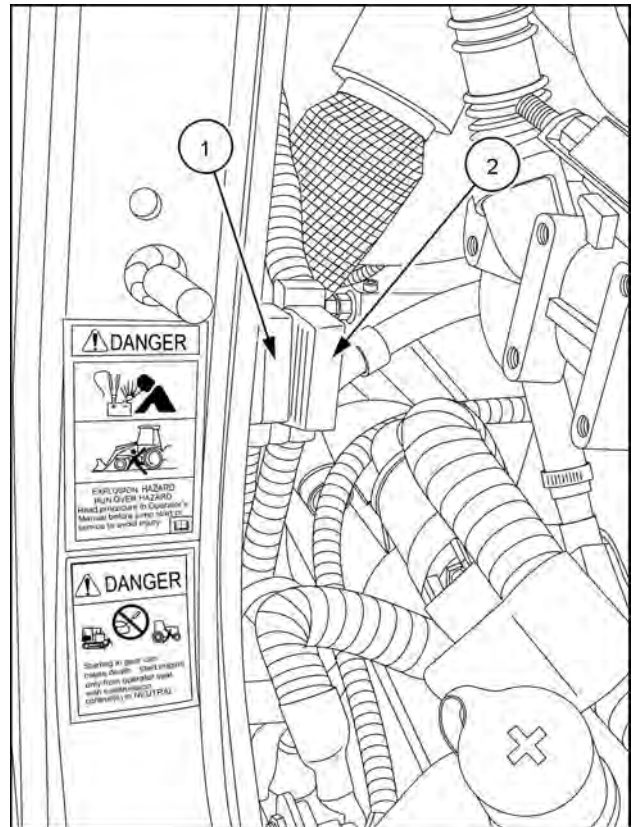

RAIL14TLB0853BA 11

Telematics system fuse

1. Raise the loader arm and engage the safety support.
2. Lift the engine hood.
3. On the right-hand side of the engine locate the wire harness with the in-line **5 A** fuse. The location of the fuse will depend on the machine configuration:
 - A. Machines equipped with the Battery Power Junction Stud **(1)** .
 - B. Machines equipped with a Master Disconnect Switch **(2)**.

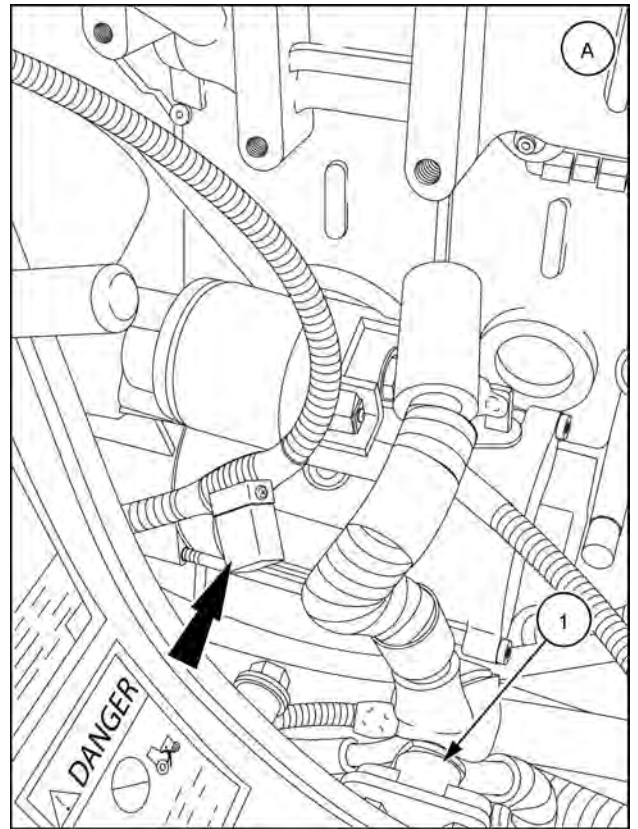

RAIL13TLB0207BA 12

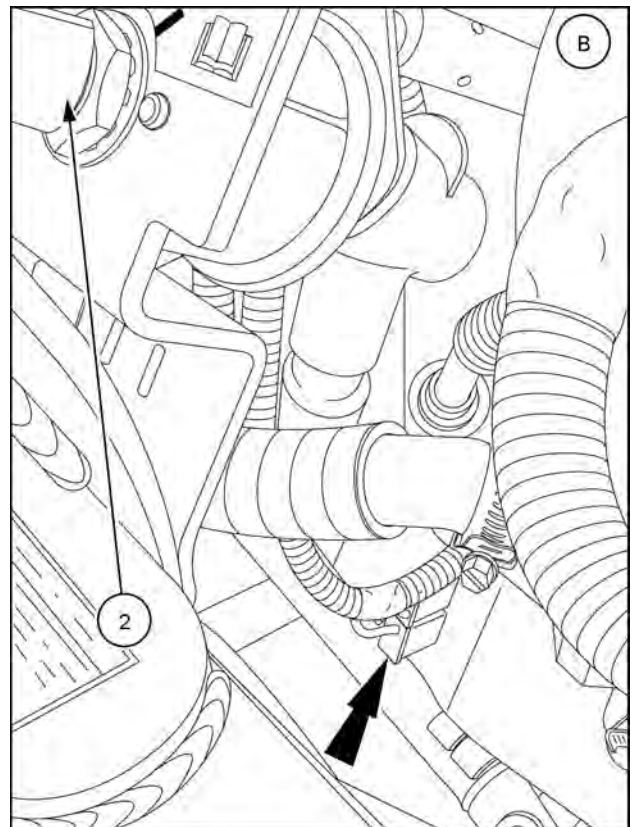

RAIL13TLB0206BA 13

Basic instructions - Fuse, relay, and diode icon definitions



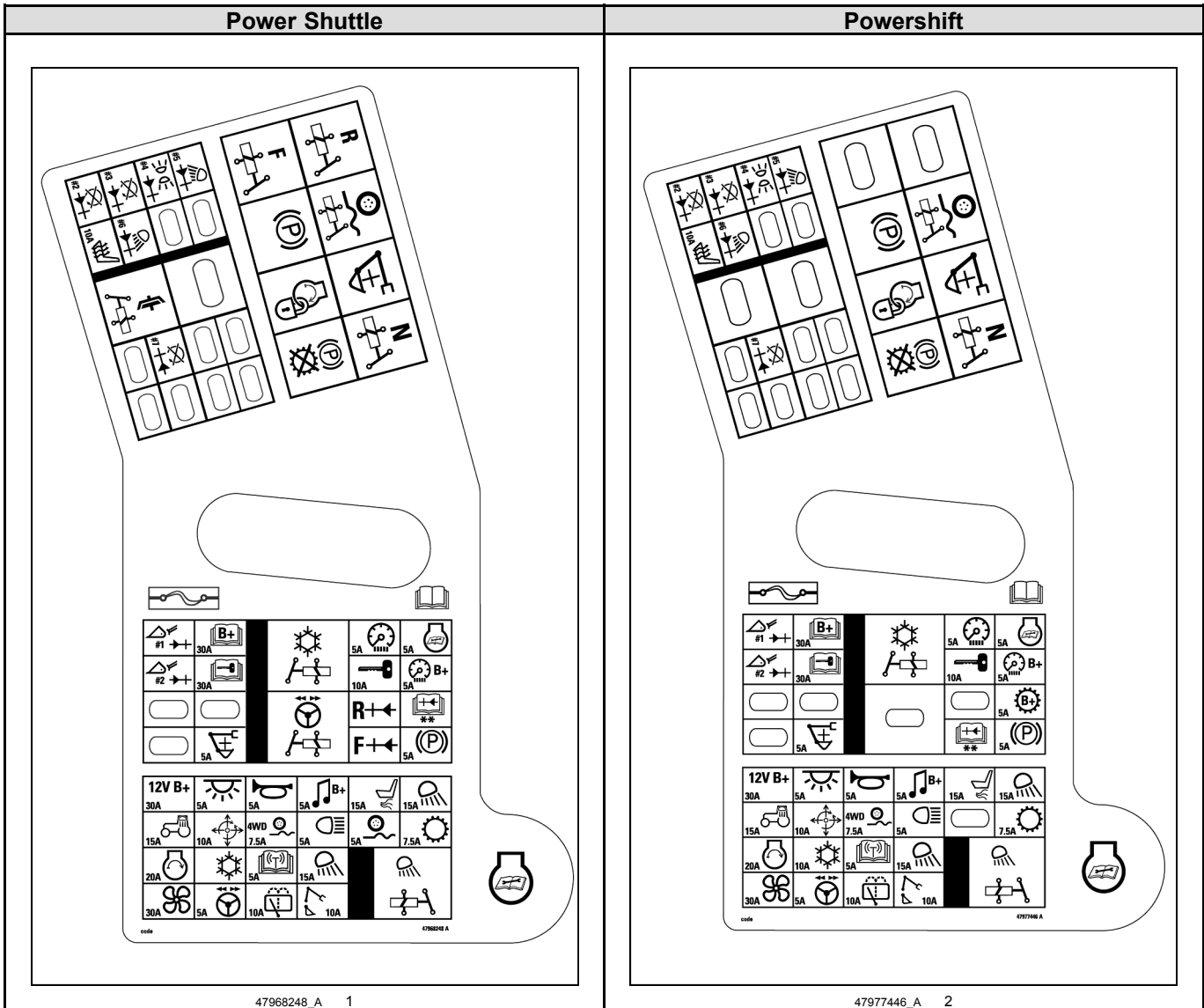





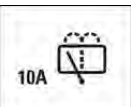

Right-hand side console panel

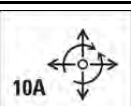
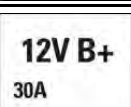
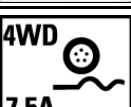

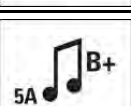



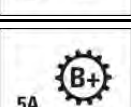





Fuse icon definitions

Symbol	Function
	Diagnostic B+
	Instrument cluster key ON
	Instrument cluster B+



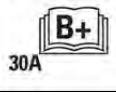

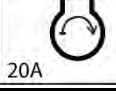

INTRODUCTION

Symbol	Function
	Rear lights
	Rear wipers/washers
	Transmission differential lock, de-clutch button, and clutch relay
	Tail lights
	Pilot controls
	Cigarette lighter plugs
	4WD, Auto Ride Control
	Dome light
	Radio B+
	Horn
	Blower motor
	A/C
	TRAX B+
	Key switch
	Air seat

INTRODUCTION

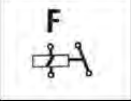
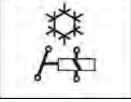

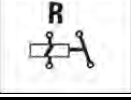
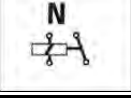

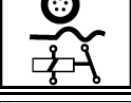
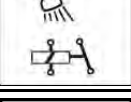
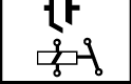

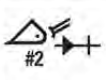
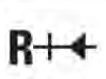

Symbol	Function
	Heated seat
	2WD, Ride Control
	Quick coupler, EH Clam, Radio Key ON
	SAHR brake
	Comfort Steer
	Side lights
	Customer B+
	Customer key ON
	Starter
	Power Lift™
	Telematics NOTE: The Telematics system has an additional external fuse location.

Relay icon definitions

Symbol	Function
	Power Lift™ relay
	SAHR park brake relay
	SAHR park brake transmission cutout relay
	Forward relay (Power Shuttle only)
	A/C relay
	Comfort Steer relay (Power Shuttle only)
	Reverse relay (Power Shuttle only)
	Neutral relay
	Starter interlock relay
	Auto Ride Control relay
	Rear light relay
	Transmission De-clutch relay (Powershift only)

INTRODUCTION





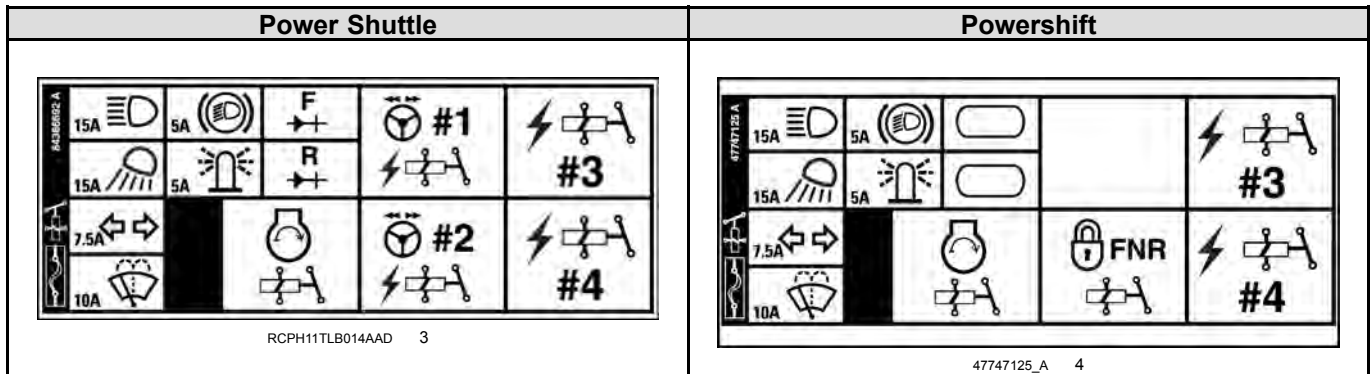

Diode icon definitions

Symbol	Function
	Quick coupler diode #1
	Quick coupler diode #2
	Reverse signal diode (Power Shuttle only)
	Forward signal diode (Power Shuttle only)
	Torque control diode
	Auto engine shutdown diode #2
	Auto engine shutdown diode #3
	Head light diode #4
	Front work light diode #5
	Rear work light diode #6
	Auto engine shutdown diode #7



Left-hand side steering column console panel





Fuse icon definitions

Symbol	Function
	Head lights
	Front work lights
	Turn signal, Hazards
	Front wiper/washer
	High beam
	Beacon

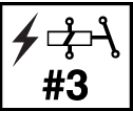
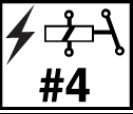

Relay icon definitions

Symbol	Function
	Comfort steer relay and Power relay #1 (Power Shuttle only)
	Comfort steer relay and Power relay #2 (Power Shuttle only)
	Transmission lock relay (Powershift only)

INTRODUCTION

Symbol	Function
	Power relay #3
	Power relay #4
	Start relay

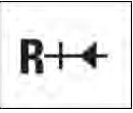
Diode icon definitions

Symbol	Function
	Reverse Signal Diode (Power Shuttle only)
	Forward Signal Diode (Power Shuttle only)

Front console fuse and relay panel

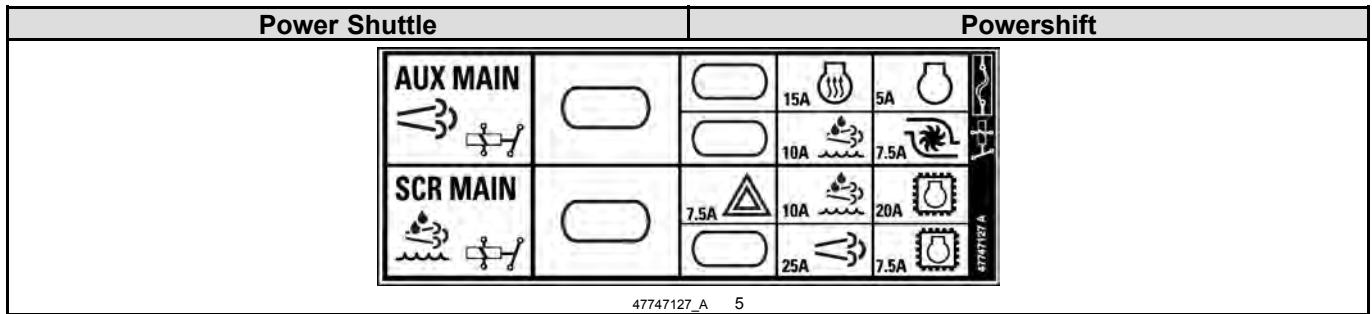

Fuse icon definitions

Symbol	Function
7.5A	Hazard lights
15A	Crankcase Ventilation (CCV) heater
10A	Unswitched Battery + to SCR pump module
10A	Unswitched Battery + to SCR heat valve and pump
25A	Unswitched Battery + to T4B and urea sensors
5A	By-pass relay battery +
7.5A	AUX main relay, electric valve, by-pass relay coil power
20A	ECU Battery +B and +C
7.5A	ECU Battery voltage

Thanks for your reading.

Please click here to download complete manual instantly.

And can also choose other manuals.

Feel free --->write to me with any questions.

Our service email:

manuals007@hotmail.com